

# RTS-1 / RTS-1C Personal Bioreactor







## 2. Safety Precautions

The following symbol means:



### **Caution!**

Make sure you have fully read and understood the present Manual before using the equipment. Please pay special attention to sections marked by this symbol.

### GENERAL SAFETY

- Use only as specified in the operating manual provided.
- The unit should not be used if dropped or damaged.
- After transportation or storage, keep the unit under room temperature for 2 - 3 h before connecting it to the electric circuit.
- Store and transport the unit at ambient temperatures between  $-20^{\circ}\text{C}$  and  $+60^{\circ}\text{C}$  and maximum relative humidity of 80%.
- Before using any cleaning or decontamination methods except those recommended by the manufacturer, check with the manufacturer that the proposed method will not damage the equipment.
- Do not make modifications in design of the unit.

### ELECTRICAL SAFETY

- Do not plug the unit into the main socket without grounding, and do not use extension lead without grounding.
- Connect only to a power supply with voltage corresponding to that on the serial number label.
- Use only the external power supply provided with this product.
- Ensure that the external power supply and switch are easily accessible during use.
- Disconnect the unit from the electric circuit before moving.
- Turn off the unit by switching off the power switch and disconnecting the external power supply from the power socket.
- If liquid penetrates into the unit, disconnect it from the external power supply and have it checked by a repair and maintenance technician.
- Do not operate the unit in premises where condensation can form. Operating conditions of the unit are defined in the **Specifications** section.

### DURING OPERATION

- Do not operate the unit in environments with aggressive or explosive chemical mixtures. Please contact manufacturer for possible operation of the unit in specific atmospheres.
- Do not operate the unit if it is faulty or has been installed incorrectly.
- Do not use outside laboratory rooms.
- Do not check the temperature by touch. Use a thermometer.
- Always clean and decontaminate the socket and the lid after operation.

### BIOLOGICAL SAFETY

- It is the user's responsibility to carry out appropriate decontamination if hazardous material is spilt on or penetrates into the equipment.
- The tube of the bioreactor must be sealed very tightly. Please see **4.5.** for instructions on testing the tubes.

### 3. General Information

Models **RTS-1** & **RTS-1C** are personal bioreactors which utilize patented Reverse-Spin® technology that applies non-invasive, mechanically driven, low energy consumption, innovative type of agitation. In it, the cell suspension is mixed by rotating a single-use falcon bioreactor tube around its axis with a change of direction of rotation motion, resulting in highly efficient mixing and oxygenation for aerobic cultivation. Combined with a near-infrared optical system, it is possible to register cell growth kinetics non-invasively in real time.

Personal bioreactor **RTS-1C** is equipped with a cooling unit that allows cooling the samples to +4°C and temperature profiling through software.

#### **The Personal Bioreactor is applicable in:**

- Microbiology
- Molecular biology
- Cell biology
- Biotechnology
- Biochemistry
- Systems Biology
- Synthetic Biology

#### **Features**

- Innovative mixing: reverse spinning of the tube with the sample around its own axis;
- With the innovative mixing technology, it is possible to measure optical density and light scattering of the sample in real time without probe interference, maintaining process sterility;
- Changing the parameters such as temperature, revolution per minute and period of spinning in one direction, together with possibility of creating experiment algorithms (including temperature profiling, mixing intensity profiling, optical density control, etc.) allows both performance of difficult sequence of algorithms of fermentation process, and achieving consistent and repeatable results.

Measurement system of the device is not working when the device is stand-alone. User must connect the device to the computer and turn on the software for the measurement system to work.

#### **Software possibilities:**

- Remote tracking and control of fermentation process.
- Real-time registration of cell growth kinetics or particle suspension aggregation/ dis-aggregation processes.
- User graphs, including 3D graphs.
- Pause.
- Saving and loading result data.
- PDF and Excel spreadsheet reports.
- Simultaneous connection of up to 10 units that allows, on one hand, to research the influence of different chemical and physical factors on fermentation process, and, on the other hand, to research the interdependence of those factors in matrix experiments.
- Calibration of the device (hardware version 9 or later).

## 4. Getting started

4.1. **Unpacking.** Remove packing materials carefully and retain them for future shipment and storage of the unit. Examine the unit carefully for any damage incurred during transit. The warranty does not cover in-transit damage.

4.2. **Complete set.** The unit set includes:

- RTS-1 / RTS-1C, Personal Bioreactor..... 1 pce
- Lid ..... 1 pce
- Bioreactor vessels TPP TubeSpin® Bioreactor 50ml..... 20 pcs
- USB data cable ..... 1 pce
- USB disk drive with software installation files..... 1 pce
- External power supply ..... 1 pce
- Software installation and operating manual..... 1 copy
- Operating Manual, Certificate..... 1 copy

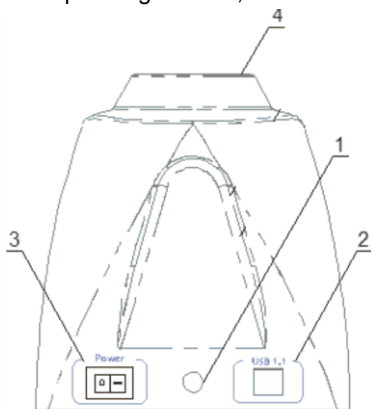

Figure 1. Rear panel

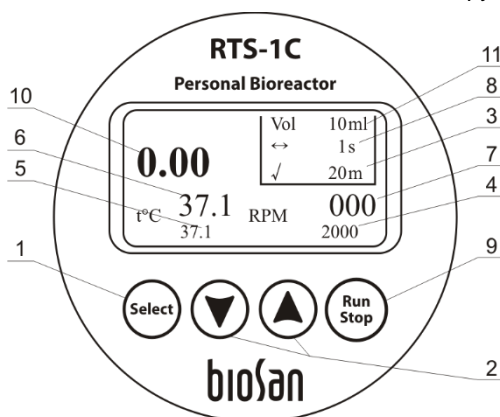

Figure 2. Control panel

4.3. **Setup.**

- Place the unit on even, horizontal working surface;
- Connect the external power supply to the socket (fig. 1/1) on the rear side of the unit;
- Switch on the computer, if it was turned off;
- Connect the USB data cable to the unit (fig. 1/2) and to the personal computer;
- Insert the USB disk drive in the personal computer and install the software following the software installation procedure described in software installation manual.

4.4. **Bioreactor vessel features:**

- Falcon type tubes. TPP TubeSpin® Bioreactor;
- Working volume 10 – 30 ml;
- Conical form;
- 5 openings (A, B, C, D, E) of different size above the gas permeable, sterile PTFE filter of the screw cap;
- Openings can be sealed and by this, exchange adjusted to need;
- Sterile gas exchange is guaranteed by the 0.22 µm filter membrane;
- Even with a high cell density the supply of oxygen through the openings is sufficient;
- Tube fits in a standard 50 ml centrifuge rotor.

- 4.5. Due to the specificity of mould type manufacturing of centrifugal falcon tubes, the helical structure of the screw caps screw thread can vary, and, given the vigorous mixing conditions, the liquid can spill if the tube is not closed tightly. Unfortunately, some of the tubes can be faulty and the liquid spillage is inevitable in at least 1 out of 60 tubes.



Before launching the experiment and leaving the device, tubes must be checked for liquid spillage occurring in a period of at least 2 minutes at 2000 RPM and  $1 \text{ s}^{-1}$  Reverse Spin (RS) with a closed lid. If droplets of liquid will appear on the inner surface of the lid, then the screw cap is faulty and the tube must be replaced.

## 5. Calibration

- 5.1. **Checking hardware version.** To check the hardware version, press ▲ and ▼ keys (fig. 2/2) simultaneously. Display will show a new screen with a unique fourteen-digit unit ID (fig. 3/1) and the hardware version (fig. 3/2). Please refer to the number in the version for further calibration. Display will change back to the previous screen after 4 seconds.

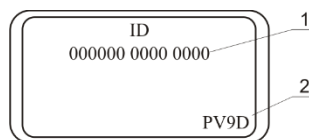

**Figure 3. ID and hardware version**

- 5.2. **Calibration verification.** The device is software calibrated (hardware version 9 or later) at the factory for specific microorganism size of  $0.4\text{-}0.8 \times 1\text{-}3 \mu\text{m}$  and a cell volume of approximately  $0.5\text{-}5.0 \mu\text{m}^3$  for operation with TPP TubeSpin® Bioreactor 50ml tube at temperature range from  $+4^\circ\text{C}$  to  $+70^\circ\text{C}$ .

To verify the conformity of calibration follow the subsequent procedures:

- Take a TPP TubeSpin® Bioreactor 50ml tube;
- Add 10ml ( $\pm 0.05\text{ml}$ ) distilled water;
- Close the cap of the tube thoroughly;
- Insert the tube into the socket (fig. 1/4);
- Connect the device to the computer, launch the software and select factory calibration;



**Note!** The software calibration works only when the device is connected to the software and appropriate factory calibration is selected in the settings.

- Set the volume parameter of the distilled water in the software;
- Set the measurement frequency to 1 minute;
- Press the **Play** button in the software;
- The device will start measuring in 1 minute and should complete after 15-20 seconds and OD value should appear on the display;
- If OD value equals  $0 (\pm 0.1 \text{ OD})$  then the device corresponds to factory pre-calibration settings and is suitable for use.

### 5.3. Creating user calibration



#### **Note!**

The device software calibration is a feature that will work for devices with hardware version 9 or later. Devices with earlier versions come pre-calibrated with a possibility to reset baseline value for device maintenance.

- 5.3.1. Get cell suspension samples in falcon tubes with typical optical densities of your experiments. If the maximal OD of your experiment (stationary phase) is 5 OD<sub>600nm</sub> then the recommended samples are 0 (ddH<sub>2</sub>O water or broth media) 1, 2, 3, 4, 5, 6 OD<sub>600nm</sub>. Volume accuracy of the samples must be  $\pm 0.05$ .

Measure OD at desired wavelength of each cell suspension using a spectrophotometer with proper prior dilutions. The proportionality between OD and cell density exists only for OD  $\leq 0.4$  (approximately), we recommend diluting samples to the range of 0.1-0.2 OD.

Multiply the dilution factor values to get the OD of the samples.

Continue to software manual page **29**.

- 5.3.2. RTS-1 / RTS-1C can be calibrated to detect scattered light of any possible cell with any possible shape and size, but due to difference of light scattering in various cell suspensions, we cannot guarantee the stated measurement range in all conditions.

- 5.4. Calibration verification for hardware versions 8 and earlier.

The device is hardware calibrated at the factory for specific microorganism size of 0.4-0.8 x 1-3  $\mu\text{m}$  and a cell volume of approximately 0.5-5.0  $\mu\text{m}^3$  for operation with 50 ml tube at temperature range from +4°C to +70°C and saves calibration data when being switched off. To verify the conformity of calibration follow the subsequent procedures.

- Take a TPP TubeSpin® Bioreactor 50 ml tube;
- Add 10ml ( $\pm 0.05\text{ml}$ ) distilled water;
- Close the cap of the tube thoroughly;
- Insert the tube into the socket (fig. 1/4);
- Set the volume parameter of the distilled water on the display (fig. 2/11);
- Press **Run Stop** key (fig. 2/9) (the device will start the OD measurement cycle by accelerating to 2000 rpm);
- The measurement cycle should complete after 15-20 seconds and OD value should appear on the display;
- If OD value equals  $0\pm 0.1$  OD, then the device corresponds to factory pre-calibration settings and is suitable for use.

If the result is unsatisfactory, please follow instructions from section **Device calibration for maintenance**.



## 6. Operation

### Recommendations during operation

- Remove the falcon tube from the tube socket before connecting or disconnecting the external power supply during operation.
- Start operation approximately 15 minutes after switching on the device (some time is necessary for stabilization in the working mode).
- Tube positioning in the tube socket must be as follows: The TPP brand name marking of the tube must align with the white marker on the rotor; this position enables the light from the LED to be transmitted without disruption by different markers presented on the tubes outer surface. White markings are available only in devices with hardware version 8 or later).



6.1. Connect external power supply to electric circuit (fig. 1/1).

6.2. Turn on the unit by pressing the power switch on the rear panel (fig. 1/3).



**Note!** After turning on the unit starts heating and continues to maintain the temperature regardless of other operations.

6.3. Insert the tube into the socket (fig. 1/4).



**Attention!** Data obtained in manual mode has a rounded and referential value.

6.4. **Software control mode.** Switch on the computer with installed software and continue working according to software operation manual.

6.5. **Manual mode.**

6.5.1. Press the **Select** key (fig. 2/1) to choose a parameter that you want to change (the active parameter is blinking).

6.5.2. Use ▲ and ▼ keys (fig. 2/2) to set the necessary value (if the key is pressed for more than 2 seconds the parameter should change quicker).

6.5.3. It is possible to set time between optical density measurements (fig. 2/3), spinning speed (fig. 2/4), temperature (fig. 2/5), time between Reverse Spins (fig. 2/8), operating volume (fig. 2/11). Actual values of the temperature and speed are displayed on the display (fig. 2/6 and fig. 2/7).

6.5.4. Press the **Run Stop** key (fig. 2/9) to start and stop operation.

6.5.5. Press the **Run Stop** key (fig. 2/9) to stop the operation.



**Caution!** Operation stop will not stop the heating process. To stop heating process set temperature has to be decreased manually until “off” indication appears (fig. 2/5).

6.6. After finishing the operation, switch OFF the unit with the Power switch (fig. 1/3).

6.7. Disconnect external power supply from electric circuit (fig. 1/1).

## 7. Recommended methods for microorganism cultivation

- 7.1. **Facultative anaerobe** *Escherichia Coli*:  
2000 rpm (vessel spinning speed),  
1 s<sup>-1</sup> (Reverse Spin Frequency, RSF),  
37° C (socket temperature),  
10-20 ml (sample volume in testing vessel),  
10 min., but not less (Measurement Frequency, **MF**)
- 7.2. **Thermophilic aerobe** *Thermophilus sp.*:  
2000 rpm,  
1 s<sup>-1</sup> RSF,  
70° C  
15 ml  
10 min MF  
Evaporation rate at 70°C = 5 ml / 24 h (please adjust Volume parameter accordingly for measurement system to work correctly)
- 7.3. **Aerotolerant anaerobe** *L. acidophilus*:  
0 rpm,  
0 s<sup>-1</sup> RSF,  
37° C,  
30 ml,  
10 min MF
- 7.4. It is possible for the end-user to contact the manufacturer for advising or suggesting a required microorganism or strain to be tested. Please contact the R&D department of Biosan at these e-mail addresses:  
**science@biosan.lv**,  
**igor@biosan.lv**,  
Igor Bankovsky, consulting biotechnologist on application questions.

## 8. Recommendations for creating personal settings for cultivation of microorganisms. Points to consider

8.1. Temperature distribution specifics (psychrophiles, mesophiles, thermophiles). The optimal growth temperatures of microorganisms are divided in three principal groups (see fig. 4):

- Psychrophiles (I) – obligate (1) and facultative (2);
- Mesophiles (II);
- Thermophiles (III) – thermotolerant (3), facultative (4), obligate (5) and extremophile (6).

Thick line mark represents optimal growth temperature.

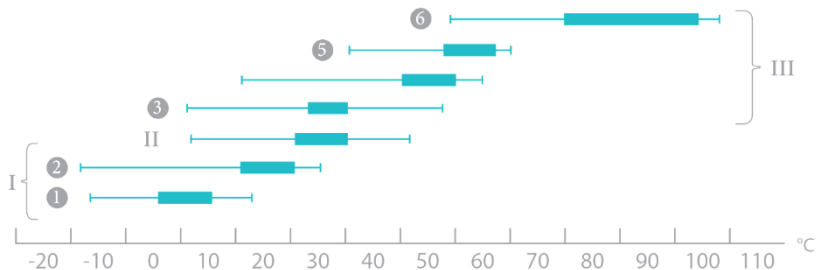

**Figure 4. Temperature borders and optimal growth zones of prokaryotes and their classification.**

8.1.1. For psychrophiles, that are cultivated at temperatures of  $15^{\circ}\text{C} \pm 2^{\circ}\text{C}$  below ambient the device must be installed in a cold room or a refrigerated chamber. Despite the active cooling of the device, the actual temperature of the reactor will always differ from the actual temperature of the sample because of its rotation and will be higher (at low temperatures below  $10^{\circ}\text{C}$ ).

8.1.2. For mesophilic microorganisms, the device can be situated at room temperature.

8.1.3. For thermophilic microorganisms, the device can be situated at room temperature.

8.2. Cell growth depending on rotation intensity

It is known that aeration affects the growth and growth rate of aerobic microorganisms. The reverse spin frequency affects the rate of oxygen uptake in the bioreactor. Results obtained indicate that the maximum rate of cell division is detected at a frequency of 1 Reverse Spin per second ( $1\text{ s}^{-1}$ ) at a speed of 2000 rpm. The increase of pause between reverse spins reduces cell growth rate, reaching 50% of the maximum value, when RS frequency is  $30\text{ s}^{-1}$  (see fig. 5. and fig. 6.).

8.2.1. Legend of experiment (fig. 5.): Personal Bioreactor RTS-1 / RTS-1C was used with 850 nm LED, volume of LB media in 50 ml Falcon tube was 15 ml, Reverse Spin Frequency 1, 2, 4, 8, 16,  $30\text{ s}^{-1}$ , measurement frequency (MF) is  $10\text{ min}^{-1}$ , reactor rotation speed 2000 rpm, temperature  $37^{\circ}\text{C}$ , diameter of filter pores (for aeration)  $0.25\text{ }\mu\text{m}$ .

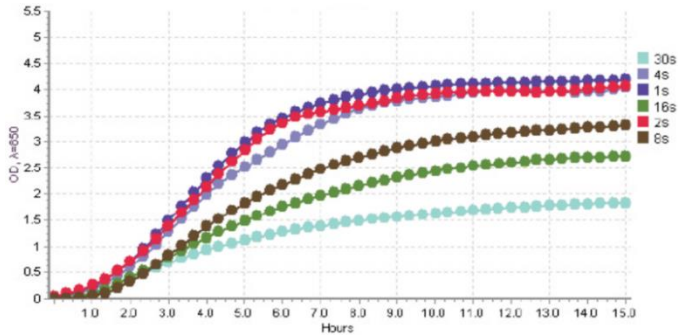

**Figure 5. Influence of Frequency of Reverse Spinning on the Growth kinetics ( $\Delta OD_{\lambda=850nm}/\Delta t$ ) vs Time of fermentation (h).**

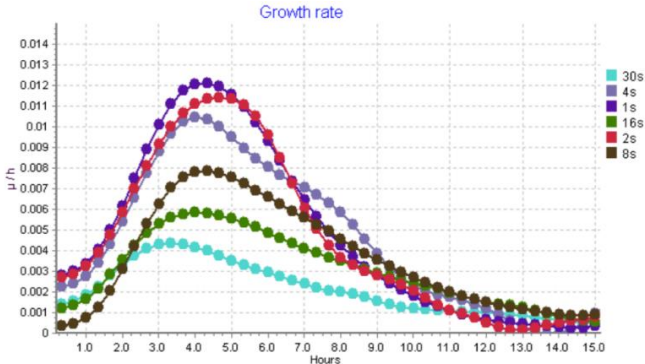

**Figure 6. Influence of Frequency of Reverse Spinning on the Growth kinetics ( $\Delta OD_{\lambda=850nm}/\Delta t$ ) vs Time of fermentation (h).**

### 8.3. Aeration and types of recommended tubes.

For aerobic microorganisms, it is recommended to use tubes that are supplied by TPP - TubeSpin® Bioreactor 50ml. For obtaining optimal results growing aerotolerant anaerobes, it is required to seal the screw cap of TPP TubeSpin® Bioreactor 50ml by tape. User can also use standard centrifuge tubes of 50 ml Falcon type, taking into account that the tube material will be as transparent as TPP TubeSpin® Bioreactor tube.

### 8.4. Factory calibration particle size and calibration coefficients 600nm/850nm

Factory calibration of the instrument is designed for specific microorganism size of 0.4-0.8 x 1-3 μm and a cell volume of approximately 0.5-5.0 μm<sup>3</sup>. In case of exceeding the allowable size, the measurement system will not work correctly.

Optical density OD<sub>λ=850 nm</sub> to OD<sub>λ=600 nm</sub> conversion rate coefficient is equal to 1.9 (cells taken for measurement from stationary phase using a spectrophotometer and 1mm optical path cuvette)

Example of calculation: to convert 3.5 OD<sub>λ=850 nm</sub> to OD<sub>λ=600 nm</sub>, multiply the result by 1.9, resulting in 6.65 OD<sub>λ=600 nm</sub>.

The microorganism that used for factory calibration is E.coli BL21. The cells are taken from shake flask night culture at stationary phase of growth.

- 8.5. Factory calibration growth phase influence on measurement accuracy  
 During the growth transition of Escherichia coli culture from the exponential growth to the stationary phase, a number of morphological and physiological changes take place, including cell volume decrease and cell shape change. Therefore, if cells taken for referent measurement using spectrophotometer at different stages from stationary phase then the correctness of measurement will be worse than specified.
- 8.6. Conversion rate coefficient of user calibration  
 Optical density  $OD_{\lambda = 850 \text{ nm}}$  to  $OD_{\lambda = 600 \text{ nm}}$  conversion rate coefficient depends on the cell size and volume. Therefore, the coefficient will be different for other cell size and volume. The device can be calibrated at desired reference wavelength to meet the needs of the user.

## 9. Temperature control

- 9.1. Rotation intensity influence on temperature accuracy of the sample  
 Rotation intensity influences air transfer introduced to the tube from the outside environment.

**Table 1. Temperature differences ( $\Delta$  t°C) between tube sample and set thermoblock temperature, depending on aerobe and microaerophilic rotation intensities at ambient temperature  $23 \text{ }^\circ\text{C} \pm 2 \text{ }^\circ\text{C}$  and  $45\% \pm 10\%$  RH.**

Set temperature on RTS, t °C	Sample real temperature t °C at 250 RPM 10s RSF s <sup>-1</sup>	Sample real temperature t °C at 2000 RPM 1s RSF s <sup>-1</sup>
70	71	67
60	61	57
50	51	48
40	40	39
30	30	29
20	18	19
10	8	10
4	4	8

- 9.2. Dew point temperature influence on measurement system accuracy  
 OD measurement accuracy is affected by moisture that can appear on the outside wall of the tube because of dew point temperature. Relative humidity and temperature affect the dew point; therefore, the temperature of the tube must be higher than the dew point temperature for the measurement system to work correctly.
- 9.2.1. Finding dew point temperature for the user.
- Find the corresponding curve on figure 7 that matches the humidity of the room in which the device is located.
  - The horizontal axis indicates the temperature of the room in which device is located.
  - Using that information, make a projection on the vertical axis. The found point on the graph is the temperature of the dew point.

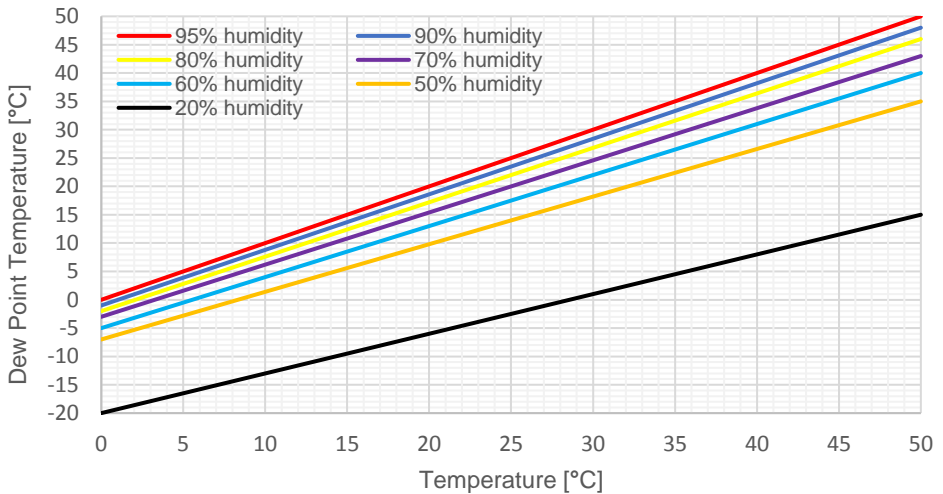

**Figure 7. Graph of dew point temperatures influenced by relative humidity.**

### 9.2.2. Avoiding dew point temperature during temperature profiling

If the dew point temperature reached, moisture will disrupt correct measurement of the system.

To avoid dew point temperature, decrease the temperature difference between the ambient temperature and bioreactor and sample temperature. By placing the bioreactor to an environmental chamber, the temperature difference can be significantly lower.

Example of calculation of environmental chamber temperature selection:

If the range of temperature profiling is from +10° C to +40° C, calculate the environmental chamber temperature:

$$(40-10) / 2 = 15^{\circ}\text{C}$$

### 9.3. Cold room and environmental chamber influence on temperature accuracy of the sample

It is possible to place the device in a cold room or environmental chamber, but the temperature of thermoblock and temperature of the sample will not be accurate at specific temperature ranges. Temperature measurements of the sample and corrections at maximum and minimum temperature ranges or 4°C-10°C and 60°C-70°C must be performed by the user. If any additional questions appear, please contact Biosan RTS support team directly for assistance. E-mail address: [igor@biosan.lv](mailto:igor@biosan.lv).

### 9.4. Change of optical characteristics of the tube depending on temperature

When temperature of the plastic material is changing, i.e. during temperature change of 30°C every hour, the plastic material of the tube changes optical characteristics in a range of ±0.1 OD.

## 10. Specification

The unit is designed for operation at ambient temperature from +4°C to +40°C in a non-condensing temperature and maximum relative humidity 80% for temperatures up to 31°C decreasing linearly to 50% relative humidity at 40°C.

Biosan is committed to a continuous program of improvement and reserves the right to alter design and specifications of the equipment without additional notice.

		RTS-1	RTS-1C
<b>Measurement specifications</b>			
Light source		LED	
Wavelength (λ), nm		850 ± 15	
E.coli BL21 Factory calibration measurement range, in OD <sub>λ850 nm</sub> , OD	at 10–20 ml volume	0-10 (0–19 OD <sub>λ600 nm</sub> equivalent)	
	at 20–30 ml volume	0-8 (0–15.2 OD <sub>λ600 nm</sub> equivalent)	
Measurement Precision, OD		±0.3	
Real time measurement, measurement/h		1 - 60	
Time setting resolution, min		1	
<b>Temperature specifications</b>			
Setting range, °C		+25...+70	+4...+70
Bottom control range point, °C		5 above ambient	15 below ambient
Top control range point, °C		70	
Setting resolution, °C		0.1	
Stability, °C		± 0.1	
Sample temperature accuracy, °C	< 20 °C	—	± 2
	5 °C above ambient ... 45 °C	± 1	—
	20 °C ... 45°C	—	± 1
	> 45 °C	± 3	± 3
Sample temperature heating rate, °C/min		1	
Sample temperature cooling rate, °C/min		1	
<b>General specifications</b>			
Sample volume, ml		10 - 30	
Speed range, rpm		50-2000	
Speed setting resolution, rpm		10	
Speed control precision <sup>1</sup> , rpm		± 15	
Display		LCD	
Overall dimensions (W × D × H), mm		130×212×200	
Weight <sup>1</sup> , kg		1.7	2.2
Input current / Power consumption		12 V DC	
		3.3 A / 40 W	5 A / 60 W
External power supply		In AC 100-240V 50/60Hz, out DC 12V	

<sup>1</sup> Accurate within ±10%.

## 11. Maintenance

- 11.1. If the unit requires maintenance, disconnect the unit from the mains and contact Biosan or your local Biosan representative.
- 11.2. All maintenance and repair operations must be performed only by qualified and specially trained personnel.
- 11.3. Standard ethanol (75%) or other cleaning agents recommended for cleaning of laboratory equipment can be used for cleaning and decontamination of the unit.
- 11.4. Clean the rotor of the device from liquid droplets and possible contamination after finishing fermentation.

## 12. Warranty and Claims

- 12.1. The Manufacturer guarantees the compliance of the unit with the requirements of Specifications, provided the Customer follows the operation, storage and transportation instructions.
- 12.2. The warranted service life of the unit from the date of its delivery to the Customer is 24 months. For extended warranty, see p. 12.5.
- 12.3. Warranty covers only the units transported in the original package.
- 12.4. If any manufacturing defects are discovered by the Customer, an unsatisfactory equipment claim shall be compiled, certified and sent to the local distributor address. Please visit the **Technical support** section on our website at the link below to obtain the claim form.



- 12.5. Extended warranty. For **RTS-1 & RTS-1C**, the *Smart* class models, extended warranty is a paid service. Contact your local Biosan representative or our service department through the **Technical support** section on our website at the link below.
- 12.6. Description of the classes of our products is available in the **Product class description** section on our website at the link below.

**Technical support**



[biosan.lv/en/support](https://biosan.lv/en/support)

**Product class description**



[biosan.lv/classes-en](https://biosan.lv/classes-en)

- 12.7. The following information will be required in the event that warranty or post-warranty service comes necessary. Complete the table below and retain for your records.

Model	RTS-1 / RTS-1C, Personal Bioreactor
Serial number	
Date of sale	

## 13. Device calibration for maintenance



**Note!**

Only use this calibration after hardware re-installation.

**Following instructions apply to:**

- Resetting baseline value for factory hardware pre-calibrated devices with hardware version 8 or earlier.
  - Adjusting RPM fluctuation for signal strength stabilization, which is required for maintenance after re-installation of hardware for all versions of the device.
- 13.1. Turn on the device.
  - 13.2. Insert a 50 ml centrifuge tube filled with 10 ml of H<sub>2</sub>O into the device.
  - 13.3. Set the Volume parameter to 10 ml.
  - 13.4. Using control panel or software unit control panel, set RPM to 2000.
  - 13.5. Press **Run/Stop** button.
  - 13.6. Press and hold **Select** button until “CC” command will appear and blink on the display.
  - 13.7. Press **▲** button and “0.00” number will appear and blink on the display.
  - 13.8. Wait 15 seconds and press **▼** button.
  - 13.9. Device is now calibrated and will make one verification measurement.

## 14. EU Declaration of Conformity

# EU Declaration of Conformity

<b>Unit type</b>	Personal bioreactors
<b>Models</b>	<b>RTS-1, RTS-1C</b>
<b>Serial number</b>	14 digits styled XXXXXYYMMZZZZ, where XXXXXX is model code, YY and MM – year and month of production, ZZZZ – unit number.
<b>Manufacturer</b>	SIA BIOSAN Latvia, LV-1067, Riga, Ratsupites str. 7/2
<b>Applicable Directives</b>	EMC Directive 2014/30/EU LVD Directive 2014/35/EU RoHS2 2011/65/EU WEEE 2012/19/EU
<b>Applicable Standards</b>	<u>LVS EN 61326-1: 2013</u> Electrical equipment for measurement, control and laboratory use. EMC requirements. General requirements. <u>LVS EN 61010-1: 2011</u> Safety requirements for electrical equipment for measurement, control, and laboratory use. General requirements. <u>LVS EN 61010-2-010: 2015</u> Particular requirements for laboratory equipment for the heating of materials. <u>LVS EN 61010-2-051: 2015</u> Particular requirements for laboratory equipment for mixing and stirring.

We declare that this product conforms to the requirements of the above Directives

  
\_\_\_\_\_  
Signature  
Svetlana Bankovska  
Managing director

19.07.2016.

Date

  
\_\_\_\_\_  
Signature  
Aleksandr Shevchik  
Engineer of R&D

19.07.2016

Date



**Biosan SIA**

Ratsupites 7, build.2, Riga, LV-1067, Latvia

Phone: +371 67860693, +371 67426137 Fax: +371 67428101

**<http://www.biosan.lv>**

Edition 3.-4.05 – July 2018