

HyBase 6100

Electric Versatile Operation Table

Technical Specifications

Dimensions	
Full length	2060mm
Height without padding	600mm-950mm
Width without side rail	520mm
Width with side rail	590mm

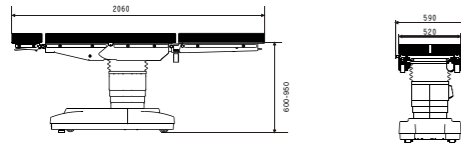

Trendelenburg position	
Trendelenburg	Max. 25°
Reverse trendelenburg	Max. 25°

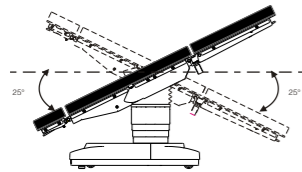

Leg plates	
Leg plates up	Max. 20°
Leg plates down	Max. 90°

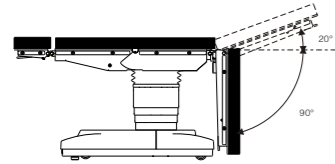

Reflex Position	
Reflex Position	110°
Trendelenburg	25°
Mounting point up	45°

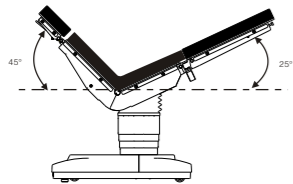

Longitudinal shift (optional)	
Head-end shift	Max. 320mm

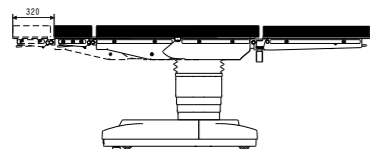

Lateral tilt	
Left tilt	Max. 20°
Right tilt	Max. 20°

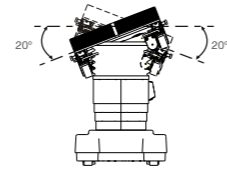

Back plate	
Back plate up	Max. 80°
Back plate down	Max. 40°

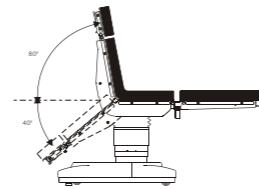

Head plate	
Head plate normal travel	Max. 45°
Head plate extended travel	Max. 90°

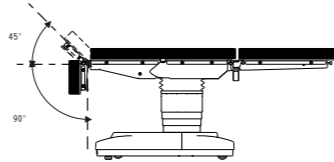

Flex Position	
Flex Position	220°
Reverse Trendelenburg	20°
Mounting point down	20°

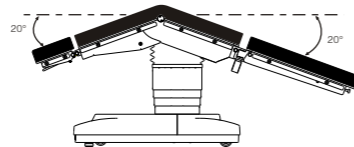

Body elevator (optional)	
Body elevator up	Max. 120mm

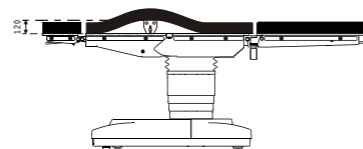

HyBase 6100 Operating Table

DISTRIBUTOR:



Mindray is the registered trademark owned by Shenzhen Mindray Bio-medical Electronics Co., LTD.
Hybase is the trademark owned by Nanjing Mindray Bio-medical Electronics Co., LTD.
© 2009-2010 Shenzhen Mindray Bio-Medical Electronics Co., Ltd. All rights Reserved.
P/N:ENG-HyBase 6100-630285-20100712

mindray

Mindray is listed on the NYSE under the symbol "MR"
Mindray Building, Keji 12th Road South, High-tech Industrial Park,
Nanshan, Shenzhen 518057, P.R. China
Tel: +86 755 26582888 Fax: +86 755 26582680
E-mail: intl-market@mindray.com Website: www.mindray.com

mindray
healthcare within reach

HyBase 6100

Electric Versatile Operation Table

Functional Display of Remote Panel



Table locked



Table released



Longitudinal shift



Longitudinal shift



Table up



Table down



Trendelenburg position



Reverse Trendelenburg position



Turn left



Turn right



Back plate up



Back plate down



Flex position



Re-flex position



Head rest up and down



Leg plate up and down, split 180°

Leg and head plates featuring same joints and completely interchangeable



Build-in elevator for kidney bridge & chest bridge



Engineered for increasingly complex surgical scenes, HyBase needs least effort and time to position the patient in a safe, comfortable and efficient way. Insightful to the surgeon and nurse's needs, Mindray is answering demands for a total solution of operating table with:

- Better mattress for the comfort of patients
- Safe and efficient patient positioning
- Know-how for maximizing the versatility



- Decompression mattress with antistatic, waterproof and seamless design
- Electric longitudinal shift for 320 mm
- Weight capacity of 250 Kg in normal position
- Weight capacity of 190 kg in reverse position
- Battery power for 50-80 operations
- 600 mm low table position for Neurosurgery & Minimal Invasive Surgery
- Electric brake system for optimum stability
- Return to original position with one button
- Flex & Reflex position with one button
- Radiolucent table plate for free C-arm access
- Three control panels including remote panel, column panel & foot switch

HyBase 6100

Electric Versatile Operation Table



Radiolucent table top with one-section leg plate for cardiovascular

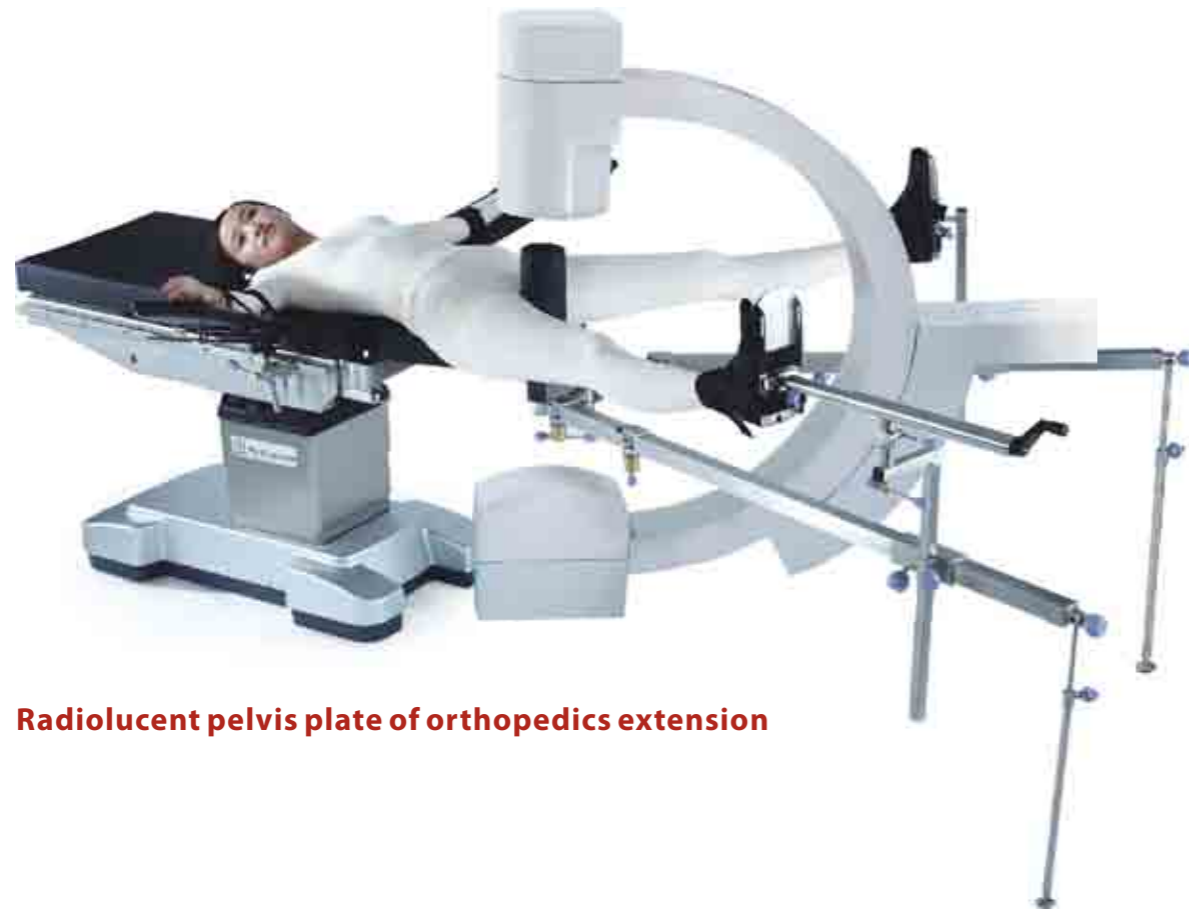

Radiolucent pelvis plate of orthopedics extension

Specialized position pad effectively decrease the incidence of decubitus ulcer

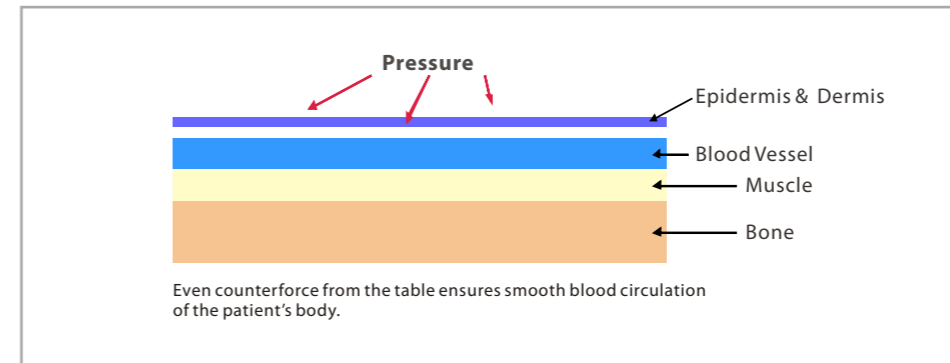
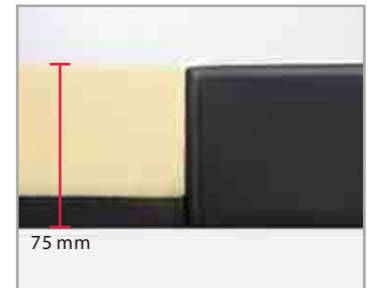

The padding can be molded by the figure of the patient, to deliver even counterforce and decrease the counterforce from some protruding parts like sacrum, iliac, ischium and calcaneus.



Decubitus ulcer

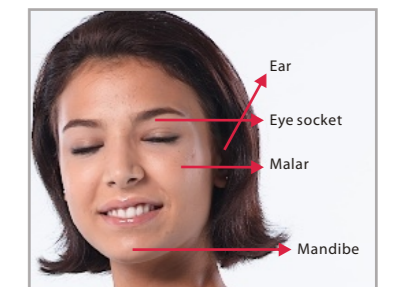
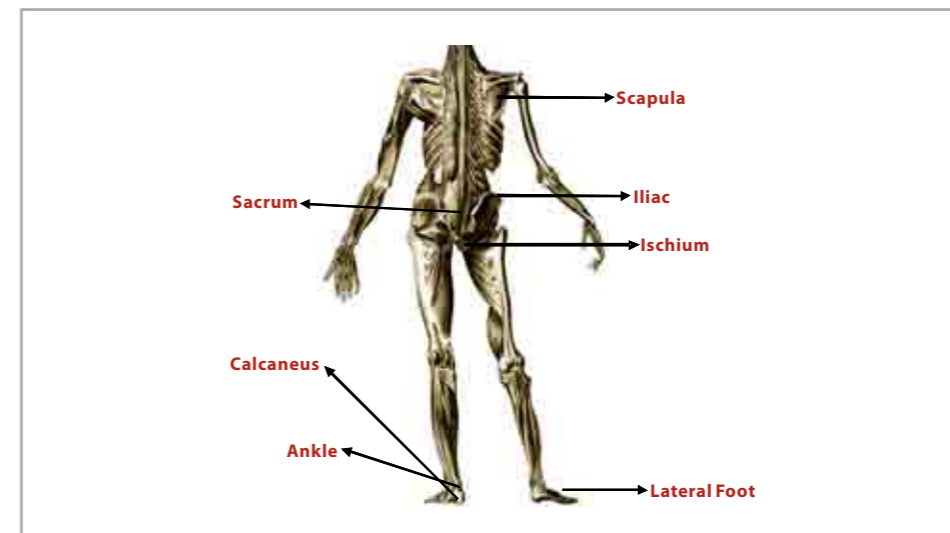

Facial parts susceptible to injuries

Easier & more comfortable for MIS



600 mm lowest height for MIS



Lithotomy position for Gynecology & Urology



Kneeling position for Intervertebral operation or rectal surgery with 2 pieces of small body support and foot boards



120mm build-in elevator



Sitting position for Neurosurgery



Beach chair position



Head support for ENT & Neurosurgery



Utilize the pad for lateral position



Pubic position support



Utilize leg support for upper arm



400 mm lower position for ENT & Neurosurgery

Note: all the patient positions in this brochure are just the example and do not represent medical points of view.

HyBase 6100

Accessories in common usage



0092-30-102646
Arm board (Light, one piece with radial universal clamp)



0092-30-102656
Universal clamp (Heavy, one piece, radial)



0092-30-102645
Anesthesia Frame (Light, one piece with light quadrate clamp)



0092-30-102635
Heavy leg support, one piece with radial universal clamp



0092-30-102634
Arm board (Heavy, one piece with radial universal clamp)



0092-30-102655
Universal clamp (Heavy, one piece, quadrate)



0092-30-102654
Anesthesia Frame (Heavy, one piece with heavy radial universal clamp)



115-005685-00(115-005683-00 PU)
One section leg plate for SFC (Special Form Core) mattress



0092-30-102648
Lateral position arm support, one piece with radial universal clamp



0092-30-102657
Universal clamp (Light, one piece, quadrate)



0092-30-102643
Infusion bottle holder, one piece with universal clamp



0092-30-102649
Shoulder support (left and right, two pieces with quadrate universal clamps)



0092-30-102658
Universal clamp (Light, one piece, radial)



115-005689-00
"U" Shape Anesthesia Frame (Light, one piece with two light quadrate clamps)



0092-30-102640
Fastening strap, one piece



0092-30-102637
Left shoulder support with pad (Heavy, one piece with quadrate universal clamp)
0092-30-102671
Right shoulder support with pad (Heavy, one piece with quadrate universal clamp)

HyBase 6100

Accessories in common usage



0092-30-102638
Large body support (Heavy, one piece with quadrate universal clamp)

0092-30-102669
Small body support (Heavy, one piece with quadrate universal clamp)



0092-30-102650
body support (left and right, two pcs with quadrate universal clamps)



0092-30-102636
Left foot plate (Heavy, one piece with quadrate universal clamp)

0092-30-102667
Right foot plate (Heavy, one piece with quadrate universal clamp)



115-005697-00
Disposal basin for Gynecology & Urology



0092-30-102642
Neurosurgical head support adapter



115-005695-00
Adjustable horseshoe shaped head support



0092-30-102641
X-ray Cassette fixer fixactor (compatible with multi-size)



0092-30-102644
Foot switch



0092-30-102639
Intervertebral disc operation pad

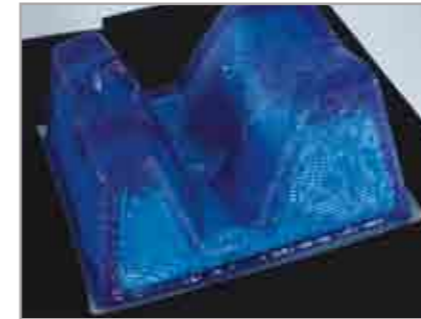

115-005864-00 Prostrate head pads(28×24×14cm)
115-005830-00 Prostrate head pads(25×20×10cm)



115-005910-00
Lateral pads



115-005788-00
Prostrate pads



115-005885-00 Horseshoe head pads(20×7×7cm)
115-005887-00 Horseshoe head pads(14×5×3cm)
115-005889-00 Horseshoe head pads(8×3×2cm)



115-005814-00
Heel pads(one piece)

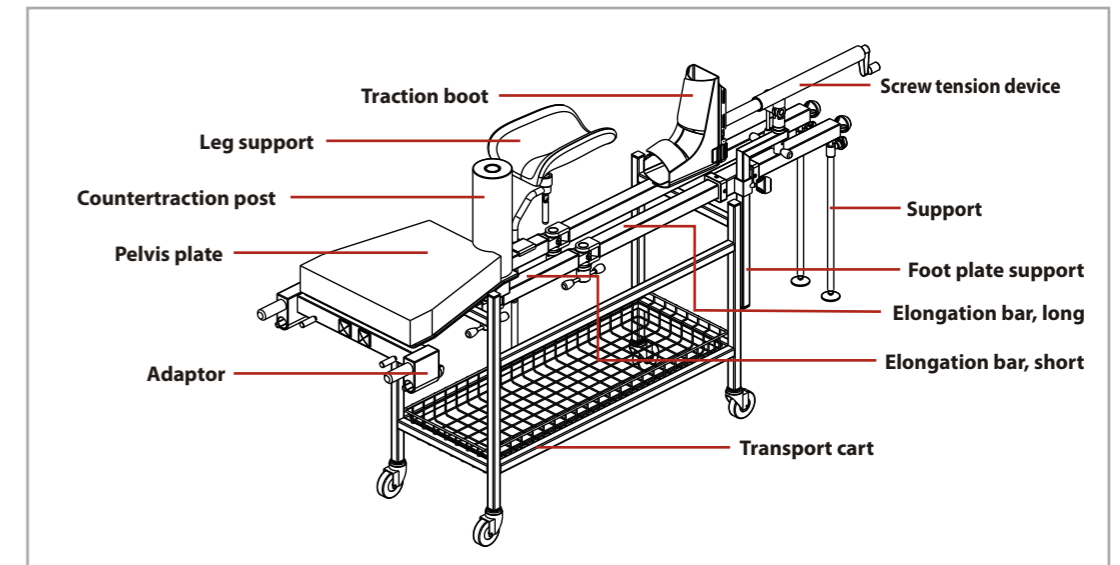

Orthopedics Extension
115-005691-00&115-005780-00(Transport Cart)